

Data sheet | Item number: 857-704

Solid-state relay module; Nominal input voltage: 24 VDC; Output voltage range: 0 ... 48 VDC; Limiting continuous current: 0.1 A; Yellow status indicator; Module width: 6 mm; gray

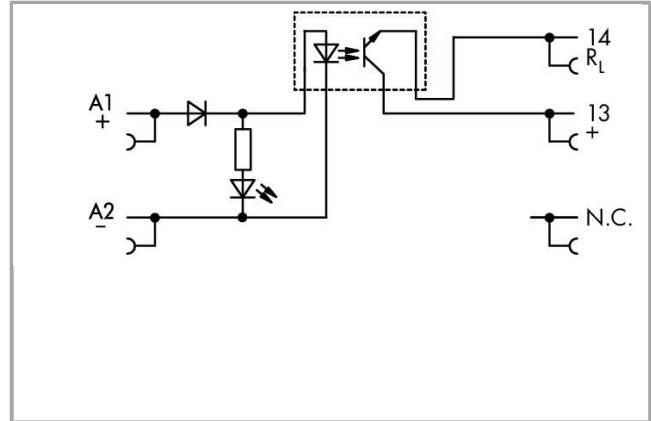

857-704



RoHS Compliant

[BOMcheck.net](https://www.bomcheck.net)

Color:

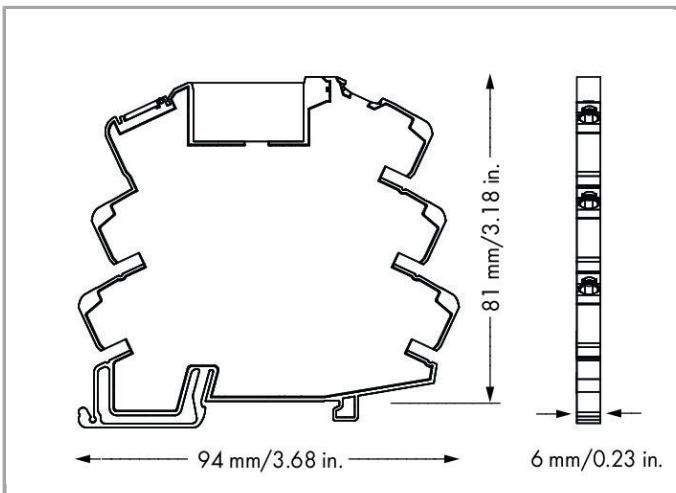

Item description

Note:

Optocouplers and solid state relays are designed for use in signal processing networks, which are not supplied by the low-voltage power supply networks.

Data

Technical Data

Control circuit

Nominal input voltage U_N	DC 24 V
Input voltage range (low level)	DC 0 10 V
Input voltage range (high level)	DC 16.8 30 V
Nominal input current at U_N	9 mA

Load circuit:

Circuit type	2-conductor termination
Limiting continuous current	0.1 A
Nominal output voltage	DC 24 V
Output voltage range	DC 0 48 V
Max. voltage drop at output	≤ DC 1 V
Leakage current at nominal voltage	≤ 1 μ A
Min. switching current	50 μ A
Turn-on time	≤ 100 μ s
Drop-out time	≤ 600 μ s
Switching frequency	≤ 1 kHz

Signaling

Status indication	LED yellow
-------------------	------------

Safety and protection:

Dielectric strength, control/load circuit (AC, 1 min)	3.75 kVrms
Protection class	IP20

Connection data

Connection technology	Push-in CAGE CLAMP®
Solid conductor	0.34 2.5 mm ² / 22 14 AWG
Fine-stranded conductor	0.34 2.5 mm ² / 22 14 AWG
Strip length	9 10 mm / 0.35 0.39 inch

Geometrical Data

Width	6 mm / 0.236 inch
Height from upper-edge of DIN-35 rail	81 mm / 3.189 inch
Depth	94 mm / 3.701 inch

Mechanical data

Type of mounting	DIN-35 rail
------------------	-------------

Material Data

Color	gray
Weight	29.789 g

Environmental Requirements

Surrounding air (operating) temperature at U_N	-20 60 °C
Surrounding air (storage) temperature	-40 70 °C
Processing temperature	-25 +50 °C

Standards and specifications



Standards/specifications	EN 61000-6-2; EN 61000-6-3; EN 61373; EN 61010-2-201; UL 508
--------------------------	--

Commercial data

Product Group	6 (Interface Electronics)
Country of origin	CN
GTIN	4045454835491
Customs Tariff No.	85364900990

Approvals / Certificates

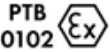
Ex-Approvals

Logo	Approval	Additional Approval Text	Certificate name
	ATEX DEKRA EXAM GmbH	EN 60079-0	BVS_14_ATEX_E_091_X
	IECEX DEKRA EXAM GmbH	IEC 60079-0	IECEX_BVS_14.0079_X

UL-Approvals

Logo	Approval	Additional Approval Text	Certificate name
------	----------	--------------------------	------------------







UL
UL International Netherlands B.V. (ORDINARY
LOCATIONS)

UL 508







E175199
Sec.4

















Compatible products















ferrule















	Item no.: 216-241 Ferrule; Sleeve for 0.5 mm ² / 20 AWG; insulated; electro-tin plated; electrolytic copper; gastight crimped; acc. to DIN 46228, Part 4/09.90; white	216-241
	Item no.: 216-242 Ferrule; Sleeve for 0.75 mm ² / 18 AWG; insulated; electro-tin plated; electrolytic copper; gastight crimped; acc. to DIN 46228, Part 4/09.90; gray	216-242
	Item no.: 216-243 Ferrule; Sleeve for 1 mm ² / AWG 18; insulated; electro-tin plated; electrolytic copper; gastight crimped; acc. to DIN 46228, Part 4/09.90; red	216-243
	Item no.: 216-244 Ferrule; Sleeve for 1.5 mm ² / AWG 16; insulated; electro-tin plated; electrolytic copper; gastight crimped; acc. to DIN 46228, Part 4/09.90; black	216-244















Marking accessories















	Item no.: 2009-110 Marking strips; on reel; not stretchable; plain; snap-on type; white	2009-110
	Item no.: 2009-115 WMB-Inline; for Smart Printer; on reel; stretchable 5 - 5.2 mm; plain; snap-on type; white	2009-115
	Item no.: 2009-115/000-002 WMB-Inline; for Smart Printer; on reel; stretchable 5 - 5.2 mm; plain; snap-on type; yellow	2009-115 /000-002
	Item no.: 2009-115/000-006 WMB-Inline; for Smart Printer; on reel; stretchable 5 - 5.2 mm; plain; snap-on type; blue	2009-115 /000-006
	Item no.: 2009-115/000-007 WMB-Inline; for Smart Printer; on reel; stretchable 5 - 5.2 mm; plain; snap-on type; gray	2009-115 /000-007
	Item no.: 2009-115/000-012 WMB-Inline; for Smart Printer; on reel; stretchable 5 - 5.2 mm; plain; snap-on type; orange	2009-115 /000-012
	Item no.: 2009-115/000-017 WMB-Inline; for Smart Printer; on reel; stretchable 5 - 5.2 mm; plain; snap-on type; light green	2009-115 /000-017

















	Item no.: 209-115/000-023 WMB-Inline; for Smart Printer; on reel; stretchable 5 - 5.2 mm; plain; snap-on type; green	2009-115 /000-023
	Item no.: 209-115/000-024 WMB-Inline; for Smart Printer; on reel; stretchable 5 - 5.2 mm; plain; snap-on type; violet	2009-115 /000-024
	Item no.: 209-128 Adaptor	209-128
	Item no.: 209-183 Marker card; white	209-183
	Item no.: 210-110 Fiber-tip pen	210-110
	Item no.: 793-501 WMB marking card; as card; not stretchable; plain; snap-on type; white	793-501
	Item no.: 793-501/000-002 WMB marking card; as card; not stretchable; plain; snap-on type; white	793-501 /000-002
	Item no.: 793-501/000-005 WMB marking card; as card; not stretchable; plain; snap-on type; white	793-501 /000-005
	Item no.: 793-501/000-006 WMB marking card; as card; not stretchable; plain; snap-on type; white	793-501 /000-006
	Item no.: 793-501/000-007 WMB marking card; as card; not stretchable; plain; snap-on type; white	793-501 /000-007
	Item no.: 793-501/000-012 WMB marking card; as card; not stretchable; plain; snap-on type; white	793-501 /000-012
	Item no.: 793-501/000-017 WMB marking card; as card; not stretchable; plain; snap-on type; white	793-501 /000-017
	Item no.: 793-501/000-023 WMB marking card; as card; not stretchable; plain; snap-on type; white	793-501 /000-023
	Item no.: 793-501/000-024 WMB marking card; as card; not stretchable; plain; snap-on type; white	793-501 /000-024
	Item no.: 793-502 WMB marking card; as card; MARKED; 1 ... 10 (10x); not stretchable; Horizontal marking; snap-on type; white	793-502
	Item no.: 793-502/000-002 WMB marking card; as card; MARKED; 1 ... 10 (10x); not stretchable; Horizontal marking; snap-on type; white	793-502 /000-002















	Item no.: 793-502/000-005 WMB marking card; as card; MARKED; 1 ... 10 (10x); not stretchable; Horizontal marking; snap-on type; white	/000-005	793-502
	Item no.: 793-502/000-006 WMB marking card; as card; MARKED; 1 ... 10 (10x); not stretchable; Horizontal marking; snap-on type; white	/000-006	793-502
	Item no.: 793-502/000-007 WMB marking card; as card; MARKED; 1 ... 10 (10x); not stretchable; Horizontal marking; snap-on type; white	/000-007	793-502
	Item no.: 793-502/000-012 WMB marking card; as card; MARKED; 1 ... 10 (10x); not stretchable; Horizontal marking; snap-on type; white	/000-012	793-502
	Item no.: 793-502/000-017 WMB marking card; as card; MARKED; 1 ... 10 (10x); not stretchable; Horizontal marking; snap-on type; white	/000-017	793-502
	Item no.: 793-502/000-023 WMB marking card; as card; MARKED; 1 ... 10 (10x); not stretchable; Horizontal marking; snap-on type; white	/000-023	793-502
	Item no.: 793-502/000-024 WMB marking card; as card; MARKED; 1 ... 10 (10x); not stretchable; Horizontal marking; snap-on type; white	/000-024	793-502
	Item no.: 793-503 WMB marking card; as card; MARKED; 11 ... 20 (10x); not stretchable; Horizontal marking; snap-on type; white		793-503
	Item no.: 793-503/000-002 WMB marking card; as card; MARKED; 11 ... 20 (10x); not stretchable; Horizontal marking; snap-on type; white	/000-002	793-503
	Item no.: 793-503/000-005 WMB marking card; as card; MARKED; 11 ... 20 (10x); not stretchable; Horizontal marking; snap-on type; white	/000-005	793-503
	Item no.: 793-503/000-006 WMB marking card; as card; MARKED; 11 ... 20 (10x); not stretchable; Horizontal marking; snap-on type; white	/000-006	793-503
	Item no.: 793-503/000-007 WMB marking card; as card; MARKED; 11 ... 20 (10x); not stretchable; Horizontal marking; snap-on type; white	/000-007	793-503
	Item no.: 793-503/000-012 WMB marking card; as card; MARKED; 11 ... 20 (10x); not stretchable; Horizontal marking; snap-on type; white	/000-012	793-503
	Item no.: 793-503/000-017 WMB marking card; as card; MARKED; 11 ... 20 (10x); not stretchable; Horizontal marking; snap-on type; white	/000-017	793-503
	Item no.: 793-503/000-023 WMB marking card; as card; MARKED; 11 ... 20 (10x); not stretchable; Horizontal marking; snap-on type; white	/000-023	793-503





	Item no.: 793-503/000-024 WMB marking card; as card; MARKED; 11 ... 20 (10x); not stretchable; Horizontal marking; snap-on type; white	793-503 /000-024
	Item no.: 793-504 WMB marking card; as card; MARKED; 21 ... 30 (10x); not stretchable; Horizontal marking; snap-on type; white	793-504
	Item no.: 793-504/000-002 WMB marking card; as card; MARKED; 21 ... 30 (10x); not stretchable; Horizontal marking; snap-on type; white	793-504 /000-002
	Item no.: 793-504/000-005 WMB marking card; as card; MARKED; 21 ... 30 (10x); not stretchable; Horizontal marking; snap-on type; white	793-504 /000-005
	Item no.: 793-504/000-006 WMB marking card; as card; MARKED; 21 ... 30 (10x); not stretchable; Horizontal marking; snap-on type; white	793-504 /000-006
	Item no.: 793-504/000-012 WMB marking card; as card; MARKED; 21 ... 30 (10x); not stretchable; Horizontal marking; snap-on type; white	793-504 /000-012
	Item no.: 793-504/000-017 WMB marking card; as card; MARKED; 21 ... 30 (10x); not stretchable; Horizontal marking; snap-on type; white	793-504 /000-017
	Item no.: 793-504/000-023 WMB marking card; as card; MARKED; 21 ... 30 (10x); not stretchable; Horizontal marking; snap-on type; white	793-504 /000-023
	Item no.: 793-505 WMB marking card; as card; MARKED; 31 ... 40 (10x); not stretchable; Horizontal marking; snap-on type; white	793-505
	Item no.: 793-505/000-005 WMB marking card; as card; MARKED; 31 ... 40 (10x); not stretchable; Horizontal marking; snap-on type; white	793-505 /000-005
	Item no.: 793-505/000-006 WMB marking card; as card; MARKED; 31 ... 40 (10x); not stretchable; Horizontal marking; snap-on type; white	793-505 /000-006
	Item no.: 793-505/000-007 WMB marking card; as card; MARKED; 31 ... 40 (10x); not stretchable; Horizontal marking; snap-on type; white	793-505 /000-007
	Item no.: 793-505/000-012 WMB marking card; as card; MARKED; 31 ... 40 (10x); not stretchable; Horizontal marking; snap-on type; white	793-505 /000-012
	Item no.: 793-506 WMB marking card; as card; MARKED; 41 ... 50 (10x); not stretchable; Horizontal marking; snap-on type; white	793-506
	Item no.: 793-506/000-005 WMB marking card; as card; MARKED; 41 ... 50 (10x); not stretchable; Horizontal marking; snap-on type; white	793-506 /000-005

	Item no.: 793-506/000-006 WMB marking card; as card; MARKED; 41 ... 50 (10x); not stretchable; Horizontal marking; snap-on type; /0000-0006 white	793-506
	Item no.: 793-506/000-012 WMB marking card; as card; MARKED; 41 ... 50 (10x); not stretchable; Horizontal marking; snap-on type; /0000-0112 white	793-506
	Item no.: 793-506/000-017 WMB marking card; as card; MARKED; 41 ... 50 (10x); not stretchable; Horizontal marking; snap-on type; /0000-0117 white	793-506
	Item no.: 793-5501 WMB marking card; as card; for terminal block width 5 - 17.5 mm; stretchable 5 - 5.2 mm; plain; snap-on type; white	793-5501
	Item no.: 793-5501/000-002 WMB marking card; as card; for terminal block width 5 - 17.5 mm; stretchable 5 - 5.2 mm; plain; snap-on type; yellow	793-5501
	Item no.: 793-5501/000-005 WMB marking card; as card; stretchable 5 - 5.2 mm; plain; snap-on type; red	793-5501
	Item no.: 793-5501/000-006 WMB marking card; as card; stretchable 5 - 5.2 mm; plain; snap-on type; blue	793-5501
	Item no.: 793-5501/000-007 WMB marking card; as card; stretchable 5 - 5.2 mm; plain; snap-on type; gray	793-5501
	Item no.: 793-5501/000-012 WMB marking card; as card; stretchable 5 - 5.2 mm; plain; snap-on type; orange	793-5501
	Item no.: 793-5501/000-014 WMB marking card; as card; stretchable 5 - 5.2 mm; plain; snap-on type; brown	793-5501
	Item no.: 793-5501/000-017 WMB marking card; as card; stretchable 5 - 5.2 mm; plain; snap-on type; light green	793-5501
	Item no.: 793-5501/000-023 WMB marking card; as card; stretchable 5 - 5.2 mm; plain; snap-on type; green	793-5501
	Item no.: 793-5501/000-024 WMB marking card; as card; stretchable 5 - 5.2 mm; plain; snap-on type; violet	793-5501
	Item no.: 793-566 WMB marking card; as card; MARKED; 1 ... 50 (2x); not stretchable; Horizontal marking; snap-on type; white	793-566
	Item no.: 793-566/000-002 WMB marking card; as card; MARKED; 1 ... 50 (2x); not stretchable; Horizontal marking; snap-on type; white	793-566

	Item no.: 793-566/000-005 WMB marking card; as card; MARKED; 1 ... 50 (2x); not stretchable; Horizontal marking; snap-on type; white	/000-005	793-566
	Item no.: 793-566/000-006 WMB marking card; as card; MARKED; 1 ... 50 (2x); not stretchable; Horizontal marking; snap-on type; white	/000-006	793-566
	Item no.: 793-566/000-007 WMB marking card; as card; MARKED; 1 ... 50 (2x); not stretchable; Horizontal marking; snap-on type; white	/000-007	793-566
	Item no.: 793-566/000-012 WMB marking card; as card; MARKED; 1 ... 50 (2x); not stretchable; Horizontal marking; snap-on type; white	/000-012	793-566
	Item no.: 793-566/000-017 WMB marking card; as card; MARKED; 1 ... 50 (2x); not stretchable; Horizontal marking; snap-on type; white	/000-017	793-566
	Item no.: 793-566/000-023 WMB marking card; as card; MARKED; 1 ... 50 (2x); not stretchable; Horizontal marking; snap-on type; white	/000-023	793-566
	Item no.: 793-566/000-024 WMB marking card; as card; MARKED; 1 ... 50 (2x); not stretchable; Horizontal marking; snap-on type; white	/000-024	793-566
transfer module			
	Item no.: 857-980 Interface adapter; 16-pole; analog		857-980
	Item no.: 857-981 Interface adapter; 14-pole; High-side switching input		857-981
	Item no.: 857-982 Interface adapter; 14-pole; High-side switching output		857-982
tools			
	Item no.: 210-720 Operating tool; Blade: 3.5 x 0.5 mm; with a partially insulated shaft		210-720
Jumper			
	Item no.: 281-482 Comb-style jumper bar; insulated; 2-way; IN = IN terminal block; gray		281-482
	Item no.: 859-402 Push-in type jumper bar; 2-way; Nominal current 18 A; insulated; light gray		859-402
	Item no.: 859-402/000-005 Push-in type jumper bar; 2-way; Nominal current 18 A; insulated; red	/000-005	859-402
	Item no.: 859-402/000-006 Push-in type jumper bar; 2-way; Nominal current 18 A; insulated; blue	/000-006	859-402

	Item no.: 859-402/000-029 Push-in type jumper bar; 2-way; Nominal current 18 A; insulated; yellow	859-402
		7000-029
	Item no.: 859-403 Push-in type jumper bar; 3-way; Nominal current 18 A; insulated; light gray	859-403
	Item no.: 859-403/000-005 Push-in type jumper bar; 3-way; Nominal current 18 A; insulated; red	859-403
		7000-005
	Item no.: 859-403/000-006 Push-in type jumper bar; 3-way; Nominal current 18 A; insulated; blue	859-403
		7000-006
	Item no.: 859-403/000-029 Push-in type jumper bar; 3-way; Nominal current 18 A; insulated; yellow	859-403
		7000-029
	Item no.: 859-404 Push-in type jumper bar; 4-way; Nominal current 18 A; insulated; light gray	859-404
	Item no.: 859-404/000-005 Push-in type jumper bar; 4-way; Nominal current 18 A; insulated; red	859-404
		7000-005
	Item no.: 859-404/000-006 Push-in type jumper bar; 4-way; Nominal current 18 A; insulated; blue	859-404
		7000-006
	Item no.: 859-404/000-029 Push-in type jumper bar; 4-way; Nominal current 18 A; insulated; yellow	859-404
		7000-029
	Item no.: 859-405 Push-in type jumper bar; 5-way; Nominal current 18 A; insulated; light gray	859-405
	Item no.: 859-405/000-005 Push-in type jumper bar; 5-way; Nominal current 18 A; insulated; red	859-405
		7000-005
	Item no.: 859-405/000-006 Push-in type jumper bar; 5-way; Nominal current 18 A; insulated; blue	859-405
		7000-006
	Item no.: 859-405/000-029 Push-in type jumper bar; 5-way; Nominal current 18 A; insulated; yellow	859-405
		7000-029
	Item no.: 859-406 Push-in type jumper bar; 6-way; Nominal current 18 A; insulated; light gray	859-406
	Item no.: 859-406/000-005 Push-in type jumper bar; 6-way; Nominal current 18 A; insulated; red	859-406
		7000-005
	Item no.: 859-406/000-006 Push-in type jumper bar; 6-way; Nominal current 18 A; insulated; blue	859-406
		7000-006

	Item no.: 859-406/000-029 Push-in type jumper bar; 6-way; Nominal current 18 A; insulated; yellow	/000-029	859-406
	Item no.: 859-407 Push-in type jumper bar; 7-way; Nominal current 18 A; insulated; light gray		859-407
	Item no.: 859-407/000-005 Push-in type jumper bar; 7-way; Nominal current 18 A; insulated; red	/000-005	859-407
	Item no.: 859-407/000-006 Push-in type jumper bar; 7-way; Nominal current 18 A; insulated; blue	/000-006	859-407
	Item no.: 859-407/000-029 Push-in type jumper bar; 7-way; Nominal current 18 A; insulated; yellow	/000-029	859-407
	Item no.: 859-408 Push-in type jumper bar; 8-way; Nominal current 18 A; insulated; light gray		859-408
	Item no.: 859-408/000-005 Push-in type jumper bar; 8-way; Nominal current 18 A; insulated; red	/000-005	859-408
	Item no.: 859-408/000-006 Push-in type jumper bar; 8-way; Nominal current 18 A; insulated; blue	/000-006	859-408
	Item no.: 859-408/000-029 Push-in type jumper bar; 8-way; Nominal current 18 A; insulated; yellow	/000-029	859-408
	Item no.: 859-409 Push-in type jumper bar; 9-way; Nominal current 18 A; insulated; light gray		859-409
	Item no.: 859-409/000-005 Push-in type jumper bar; 9-way; Nominal current 18 A; insulated; red	/000-005	859-409
	Item no.: 859-409/000-006 Push-in type jumper bar; 9-way; Nominal current 18 A; insulated; blue	/000-006	859-409
	Item no.: 859-409/000-029 Push-in type jumper bar; 9-way; Nominal current 18 A; insulated; yellow	/000-029	859-409
	Item no.: 859-410 Push-in type jumper bar; 10-way; Nominal current 18 A; insulated; light gray		859-410
	Item no.: 859-410/000-005 Push-in type jumper bar; 10-way; Nominal current 18 A; insulated; red	/000-005	859-410

	Item no.: 859-410/000-006 Push-in type jumper bar; 10-way; Nominal current 18 A; insulated; blue		859-410
		/000-006	
	Item no.: 859-410/000-029 Push-in type jumper bar; 10-way; Nominal current 18 A; insulated; yellow		859-410
		/000-029	
General accessories			
	Item no.: 209-184 Protection cover; transparent		209-184
	Item no.: 249-105 Group marker carrier		249-105
	Item no.: 857-164 Basic solid-state relay; Nominal input voltage: 24 VDC; Output voltage range: 0 ... 48 VDC		857-164

Downloads

Documentation

Instruction Leaflet

Stecksocket mit Optokoppler Eingangsnennspannung DC 24 V, Schaltstrom 0,1 A		pdf 2.4 MB	Download
--	--	---------------	----------

Additional Information

Disposal; Electrical and electronic equipment, Packaging	V 1.0.0	pdf 265.8 kB	Download
--	---------	-----------------	----------

CAD/CAE - Smart Data

CAD data

3D Download 857-704		URL	Download
Step file 857-07xx Series	1.0 Jun 30, 2011	STP 299.3 kB	Download

EPLAN

EPLAN Data Portal			Download
-------------------	--	--	----------

WSCAD

WSCAD Universe			Download
----------------	--	--	----------



Subject to changes.
